

Standard Recovery Diodes (Hockey PUK Version), 1100A/1400A

FEATURES

- Wide current range
- High voltage ratings up to 3200 V
- High surge current capabilities
- Diffused junction
- Hockey PUK version
- Case style B-43(E-PUK), Nell's B-type Capsule
- Lead (Pb)-free

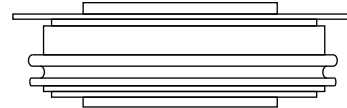

B-43(E-PUK)
(Nell's B-type Capsule)

TYPICAL APPLICATIONS

- Converters
- Power supplies
- Machine tool controls
- High power drives
- Medium traction applications

PRODUCT SUMMARY

$I_{F(AV)}$	1100A/1400A
-------------	-------------

MAJOR RATINGS AND CHARACTERISTICS

PARAMETER	TEST CONDITIONS	D1100B		UNIT
		08 TO 20	25 TO 32	
$I_{F(AV)}$		1400	1100	A
	T_{hs}	55	55	°C
$I_{F(RMS)}$		2500	2000	A
	T_{hs}	25	25	°C
I_{FSM}	50 HZ	13000	10500	A
	60 HZ	13610	11000	
I^2t	50 HZ	845	551	kA ² s
	60 HZ	768	502	
V_{RRM}		800 to 2000	2500 to 3200	V
T_J	Typical	-40 to 175	-40 to 150	°C

ELECTRICAL SPECIFICATIONS

VOLTAGE RATINGS

TYPE NUMBER	VOLTAGE CODE	V_{RRM} , MAXIMUM REPETITIVE PEAK REVERSE VOLTAGE V	V_{RSM} , MAXIMUM NON-REPETITIVE PEAK REVERSE VOLTAGE V	I_{RRM} , MAXIMUM AT $T_J = T_J$ MAXIMUM mA
D1100B	08	800	900	35
	12	1200	1300	
	16	1600	1700	
	20	2000	2100	
	25	2500	2600	
	30	3000	3100	
	32	3200	3300	

Nell High Power Products

FORWARD CONDUCTION							
PARAMETER	SYMBOL	TEST CONDITIONS			D1100B		UNIT
					08 to 20	25 to 32	
Maximum average forward current at heatsink temperature	$I_{F(AV)}$	180° conduction, half sine wave Double side (single side) cooled			1400 (795)	1100 (550)	A
					55 (85)	55 (85)	°C
Maximum RMS forward current	$I_{F(RMS)}$	25°C heatsink temperature double side cooled			2500	2000	A
Maximum peak, one cycle non-repetitive surge current	I_{FSM}	t = 10ms	No voltage reapplied	Sinusoidal half wave, initial $T_J = T_J$ maximum	13000	10500	A
		t = 8.3ms			13610	11000	
		t = 10ms	100% V_{RRM} reapplied		10920	8820	
		t = 8.3ms			11430	9240	
Maximum I^2t for fusing	I^2t	t = 10ms	No voltage reapplied		845	551	kA^2s
		t = 8.3ms			768	502	
		t = 10ms	100% V_{RRM} reapplied		601	389	
		t = 8.3ms			548	354	
Maximum $I^2\sqrt{t}$ for fusing	$I^2\sqrt{t}$	t = 0.1 to 10 ms, no voltage reapplied			8450	5510	$kA^2\sqrt{s}$
Low level value of threshold voltage	$V_{F(TO)1}$	$(16.7\% \times \pi \times I_{F(AV)} < I < \pi \times I_{F(AV)})$ $T_J = T_J$ maximum			0.78	0.84	V
High level value of threshold voltage	$V_{F(TO)2}$	$(I > \pi \times I_{F(AV)})$, $T_J = T_J$ maximum			0.94	0.98	
Low level value of forward slope resistance	r_{t1}	$(16.7\% \times \pi \times I_{F(AV)} < I < \pi \times I_{F(AV)})$ $T_J = T_J$ maximum			0.35	0.40	mΩ
High level value of forward slope resistance	r_{t2}	$(I > \pi \times I_{F(AV)})$, $T_J = T_J$ maximum			0.26	0.38	
Maximum forward voltage drop	V_{FM}	$I_{pk} = 1500A$, $T_J = T_J$ maximum, $t_p = 10$ ms sinusoidal wave			1.30	1.45	V

THERMAL AND MECHANICAL SPECIFICATIONS					
PARAMETER	SYMBOL	TEST CONDITIONS		VALUES	UNIT
Maximum junction operating temperature range	T_J	800V to 2000V		-40 to 175	°C
		2500V to 3200V		-40 to 150	
Maximum storage temperature range	T_{stg}			-40 to 200	
Maximum thermal resistance, junction to heatsink	R_{thJ-hs}	DC operation single side cooled		0.076	K/W
		DC operation double side cooled		0.038	
Mounting force, ±10%				9800 (1000)	N (kg)
Approximate weight				83	g
Case style		B-43 (E-PUK), Nell's B-type Capsule			

△ R_{thJC} CONDUCTION						
CONDUCTION ANGLE	SINUSOIDAL CONDUCTION		RECTANGULAR CONDUCTION		TEST CONDUCTIONS	UNITS
	SINGLE SIDE	DOUBLE SIDE	SINGLE SIDE	DOUBLE SIDE		
180°	0.007	0.007	0.005	0.005	$T_J = T_J$ maximum	K/W
120°	0.008	0.008	0.008	0.008		
90°	0.010	0.010	0.011	0.011		
60°	0.015	0.015	0.016	0.016		
30°	0.026	0.026	0.026	0.026		

Note

• The table above shows the increment of thermal resistance R_{thJ-hs} when devices operate at different conduction angles than DC

Fig.1 Current ratings characteristics

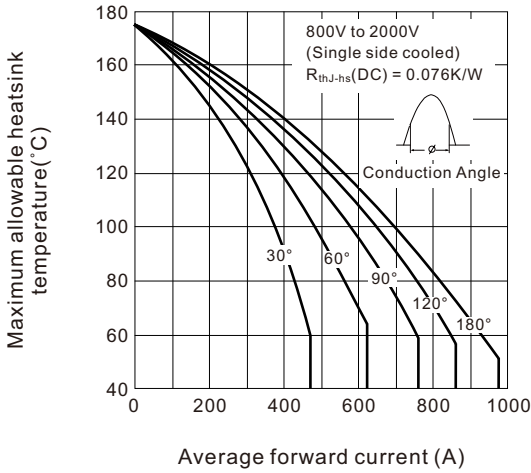

Fig.2 Current ratings characteristics

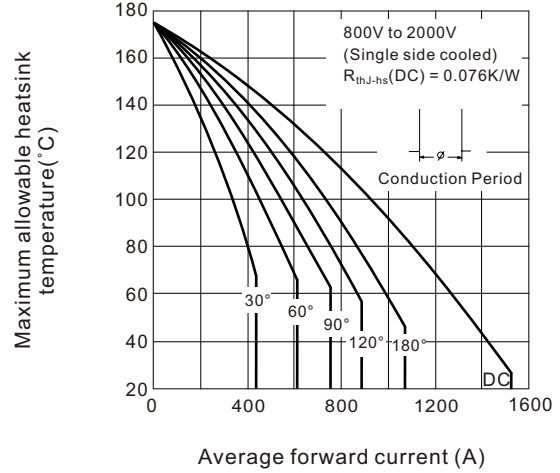

Fig.3 Current ratings characteristics

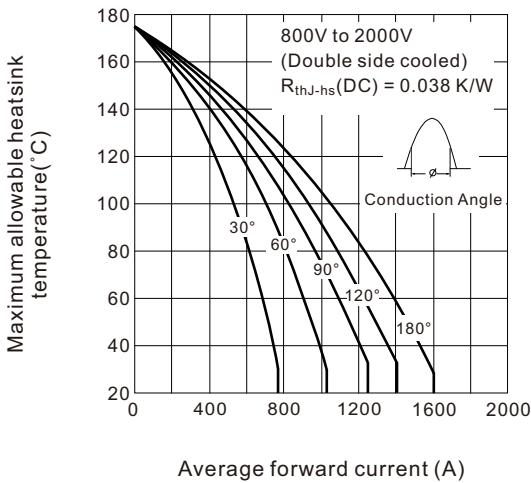

Fig.4 Current ratings characteristics

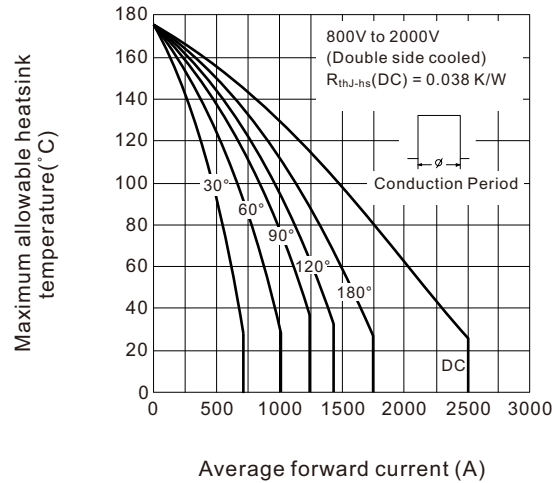

Fig.5 Forward power loss characteristics

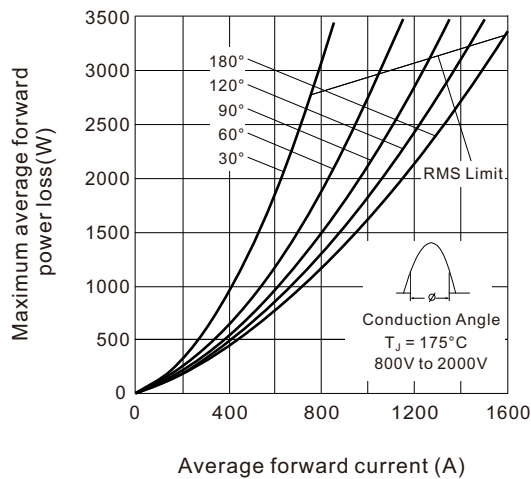

Fig.6 Forward power loss characteristics

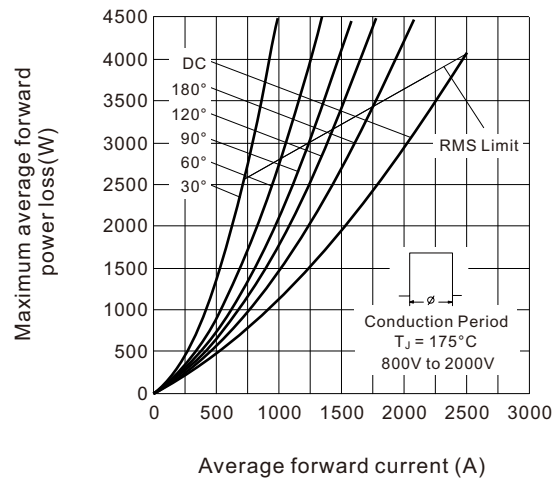

Fig.7 Maximum non-repetitive surge current single and double side cooled

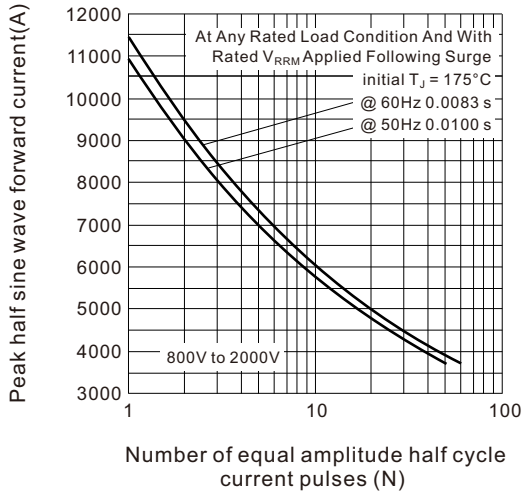

Fig.8 Maximum non-repetitive surge current single and double side cooled

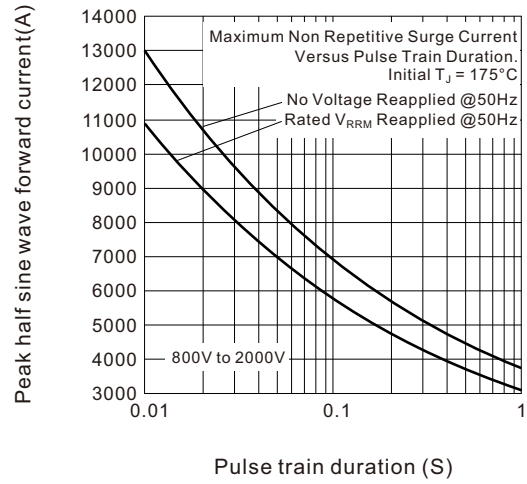

Fig.9 Current ratings characteristics

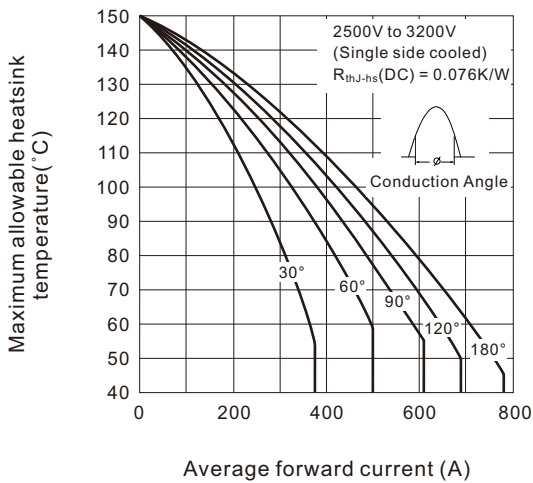

Fig.10 Current ratings characteristics

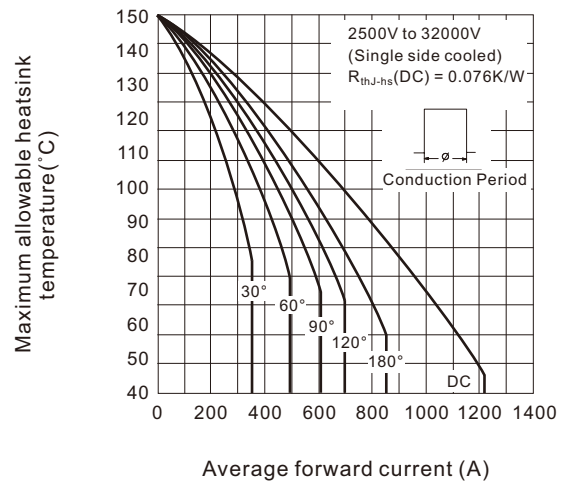

Fig.11 Current ratings characteristics

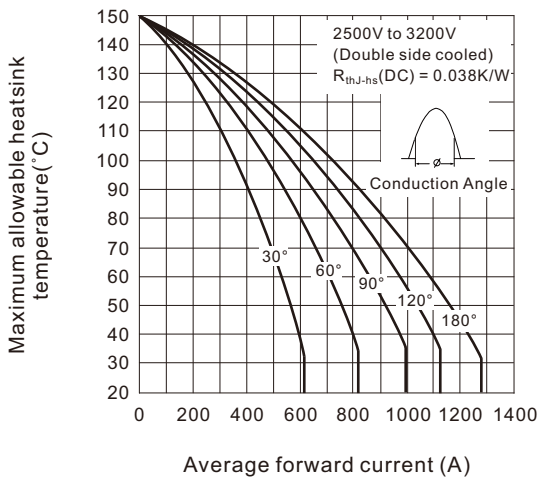

Fig.12 Current ratings characteristics

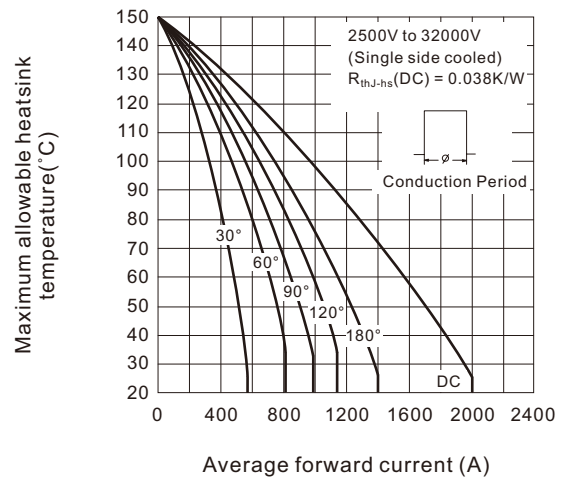

Fig.13 Forward power loss characteristics

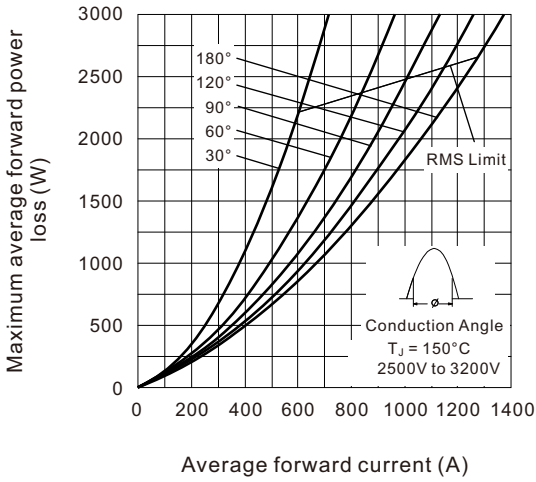

Fig.14 Forward power loss characteristics

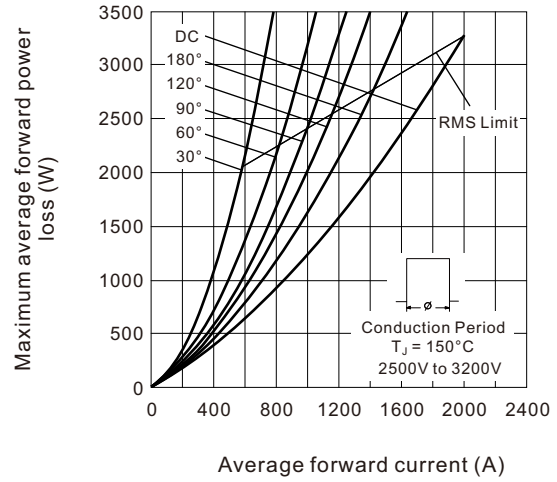

Fig.15 Maximum non-repetitive surge current single and double side cooled

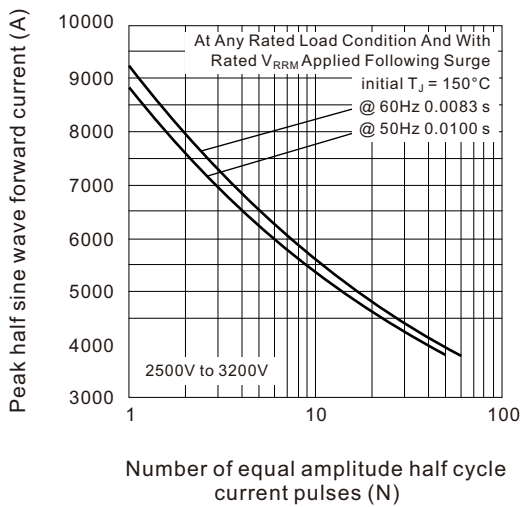

Fig.16 Maximum non-repetitive surge current single and double side cooled

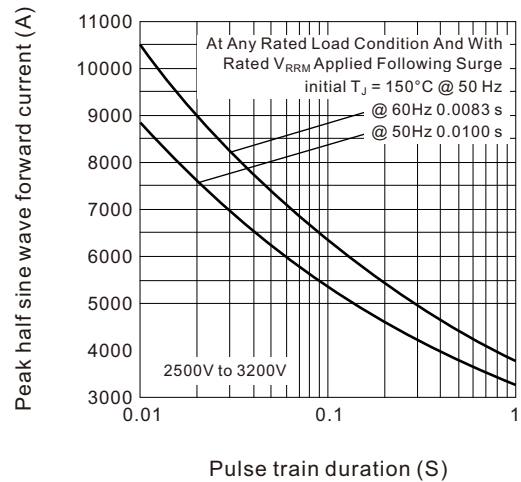

Fig.17 Forward voltage drop characteristics

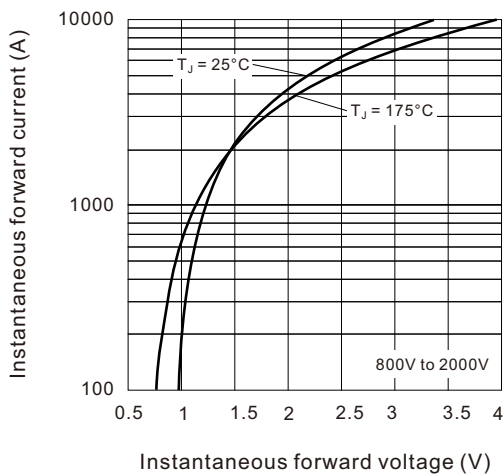

Fig.18 Forward voltage drop characteristics

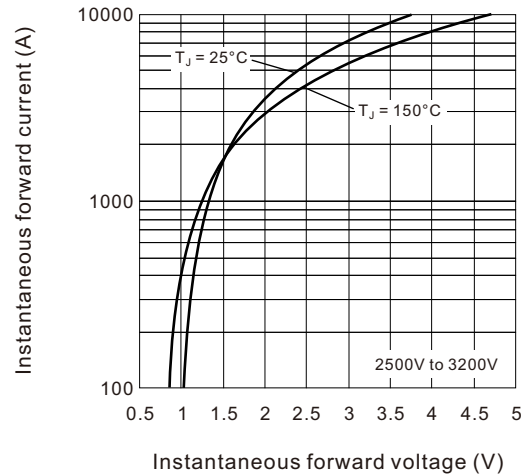
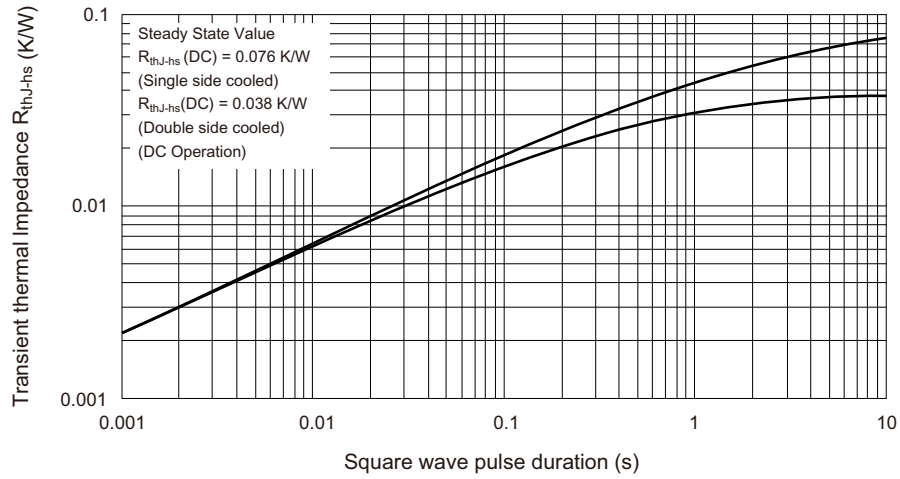

Fig.19 Thermal Impedance R_{thJ-hs} characteristics



ORDERING INFORMATION TABLE

Device code	D	1100	B	20
	①	②	③	④

- ① - "D" for standard recovery diode
- ② - Maximum average forward current, "1100" for 1400A and 1100A
- ③ - Case style : "B" for Nell's B-type Capsule, B-43 (E-PUK)
- ④ - Voltage code, code x 100 = V_{RRM}

B-43 (E-PUK), Nell's B-type Capsule

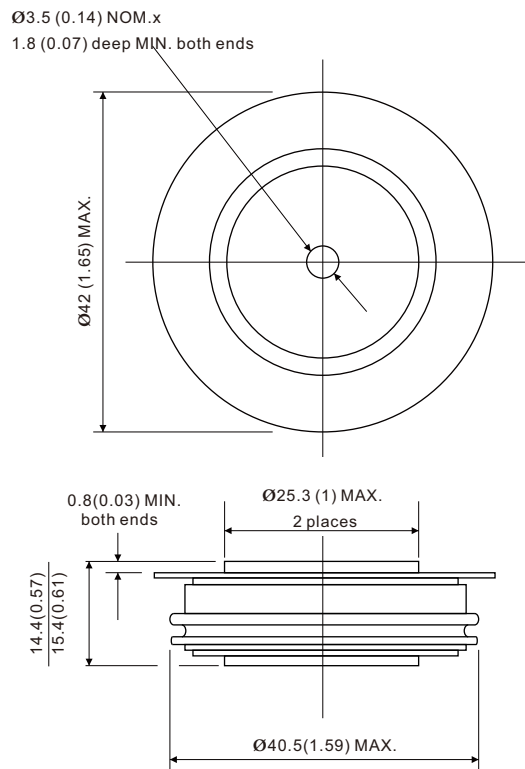

All dimensions in millimeters (inches)

